

HVL - CS

Digital Chair Scale

INSTRUCTION MANUAL V3.0

AND

A&D Mercury Pty. Ltd.

www.andmercury.com.au

Table of Contents

1. General Description	3
2. Preparation for use	3
2.1. Power source	3
3. Installing the Batteries	4
4. Chair.....	5
4.1. Safety breaks.....	5
4.2. Footrest	5
4.3. Handle	5
5. Display and Symbols	6
6. Weighing.....	7
7. Dimensions	8

1. General Description

The HVL-CS is an ergonomic digital chair scale designed for patient comfort and ease of use in the hospital / nursing home environment. The weight is displayed on a battery powered digital indicator in clear numbers on a high contrast liquid crystal display. The chair is supported on a five wheel frame, and safety brakes are provided in all five wheels. A footrest at the front allows the patient to sit comfortably in the chair. For moving the scale between locations a convenient push handle is fitted at the rear of the chair. All surfaces are easy to clean and may be wiped with a damp cloth.

2. Preparation for use

2.1. Power source

The HVL-CS digital chair scale may be powered from dry batteries, (normally already fitted to your scale), an optional AC power adapter, or from an optional rechargeable battery pack (AD-1681). If the batteries are not already in place in your scale please refer to page 2, "Installing the Batteries".

3. Installing the Batteries

Step 1 Turn off the display.

Step 1

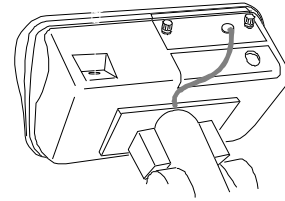

Step 2 Press and slide to open the external cover. Press the hook of the internal cover to the left side and lift the cover.

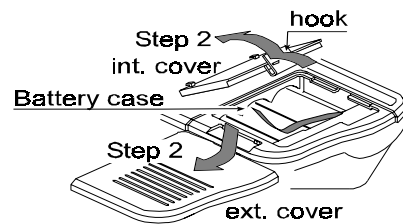

Step 3 Insert six new dry cells ensuring correct polarity (+,-). Battery size is 'D'

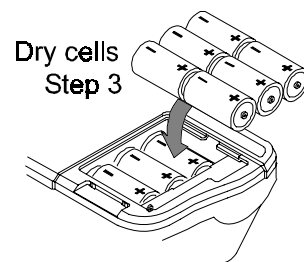

Step 4 Close the covers opened in step 2.

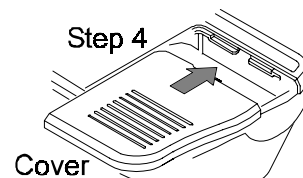

Cautions

Replace used dry cells with six new ones, when **BATT** is displayed.
Do not mix used and new batteries. It may cause damage to the battery or product.

Check the polarity when installing the batteries. If you do not observe this it may cause battery leakage. Also if the polarity of a battery is wrong the scale may only work temporarily.

The battery life is dependent upon the environmental temperature. Remove batteries from the display unit when the scale is not to be used for a long time. They may leak and cause damage.

Damage which is due to battery leakage is not covered under warranty.

4. Chair

4.1. Safety breaks

The chair is mounted upon the wheel base in such a manner as to provide the maximum stability for the patient. The brakes should be applied securely to a minimum of two wheels whenever the scale is in use. The chair scale can easily be moved from one area to another by releasing the brakes and then pushing the scale forward by use of the rear mounted handle. To apply the brakes press firmly down on the black tab in the wheel with the foot.

To release the brakes lift the black tab in the wheel with the foot.

Cautions

Scale should only be moved when empty.

It is not to be used to transport persons.





4.2. Footrest

A footrest is provided to allow the patient to sit comfortably and provide a stable weight reading. For easy access to the chair the footrest can be raised up each side to provide a clear area for the patient to stand.

4.3. Handle

A handle is provided, at the rear of the display, to allow the chair to be easily moved from area to area once the brakes have been released.

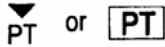
5. Display and Symbols

	<p>Stability mark. When the current weight value is not changing, this mark is displayed. The reading may now be taken.</p>
	<p>Zero point mark. With nothing on the pan and pressing the ZERO switch, this mark is displayed. The zero point is the starting point to weighing.</p>
	<p>Net mark. After pressing the TARE switch this mark is displayed to show net weight is displayed</p>
	<p>Preset tare mark. When storing a tare with digital input this mark blinks.</p>
	<p>When the battery power is low this mark is displayed. Replace with six new batteries.</p>
<p>Weighed mass value unit</p> 	<p>Example:</p> <ul style="list-style-type: none"> -Display of zero (zero point). With an empty weighing pan by pressing the ZERO switch. -The Zero mark is displayed. -The stability mark is displayed.

6. Weighing

To weigh a patient the following steps should be carried out:

1. Ensure that the chair is correctly positioned with the black brake tabs at the rear of the chair.
2. Ensure that the safety brakes are firmly applied and that the footrest is in the up position.
3. Ensure the seat is empty and switch on the scale.
4. Wait for the reading to show 0.00 kg
5. Assist the patient into the chair and lower the footrest, placing the patient's feet comfortably.
6. Watch for the STABLE circle to light and then read the weight from the display.
7. Raise the footrest and assist the patient in leaving the chair.

7. Dimensions

All dimensions are in millimetres

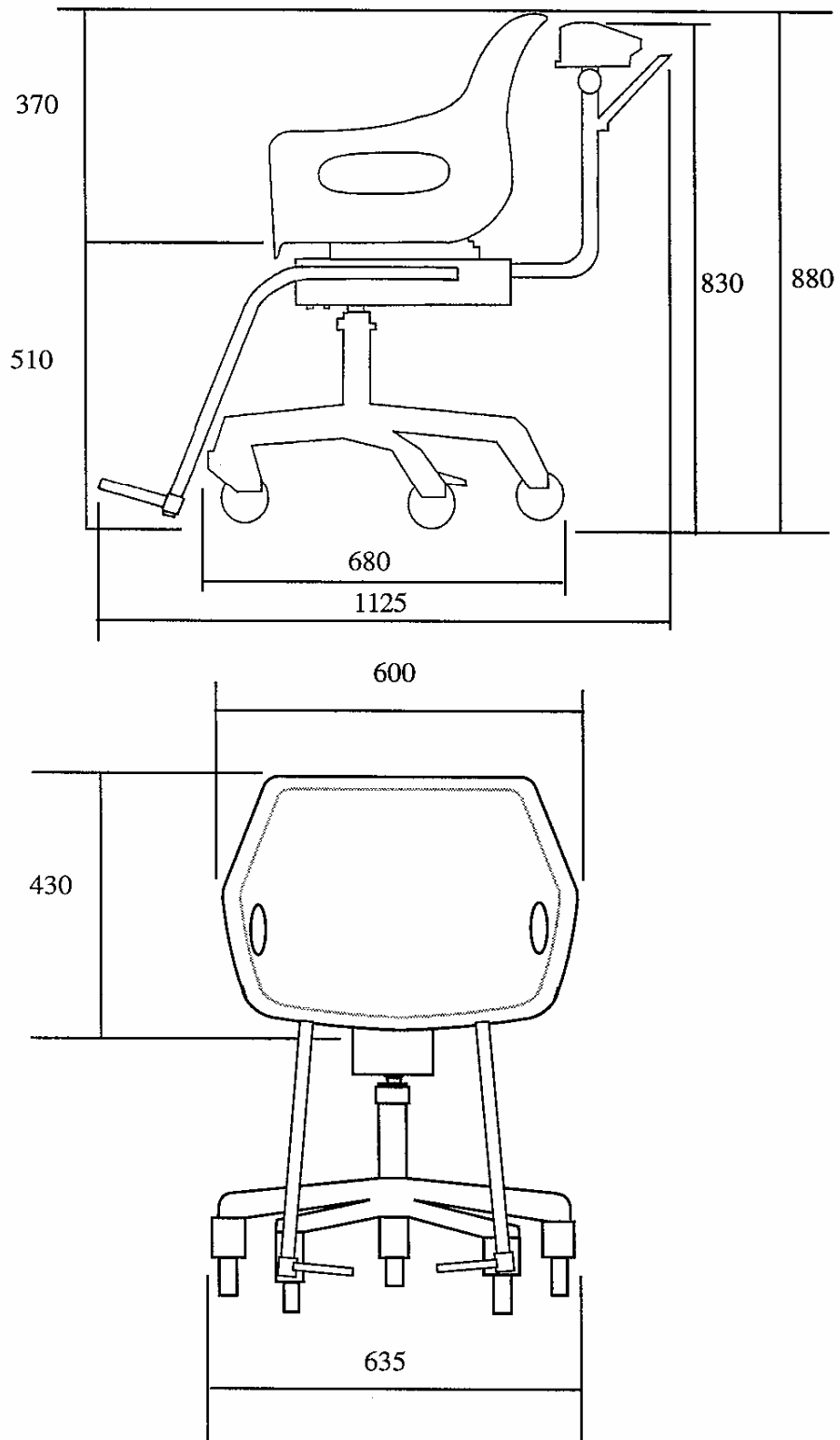



HEAD OFFICE:

32 Dew Street, Thebarton, S.A. 5031

Tel: (08) 8352-3033

Fax:(08) 8352-7409

VICTORIAN OFFICE:

Unit 4

313 Arden Street, Kensington, VIC. 3031

Tel: (03) 9372-1522

Fax:(03) 9372-1193

NSW OFFICE:

Unit 4, 14 Abbott Road, Seven Hills, NSW 2147

Tel: (02) 9674-5466

Fax:(02) 9674-2544

Internet Address:

<http://www.andmercury.com.au>